

getekend	Fredsbouwtekeningen.nl	2 van 5
Tweepersoons opklapbed		A3

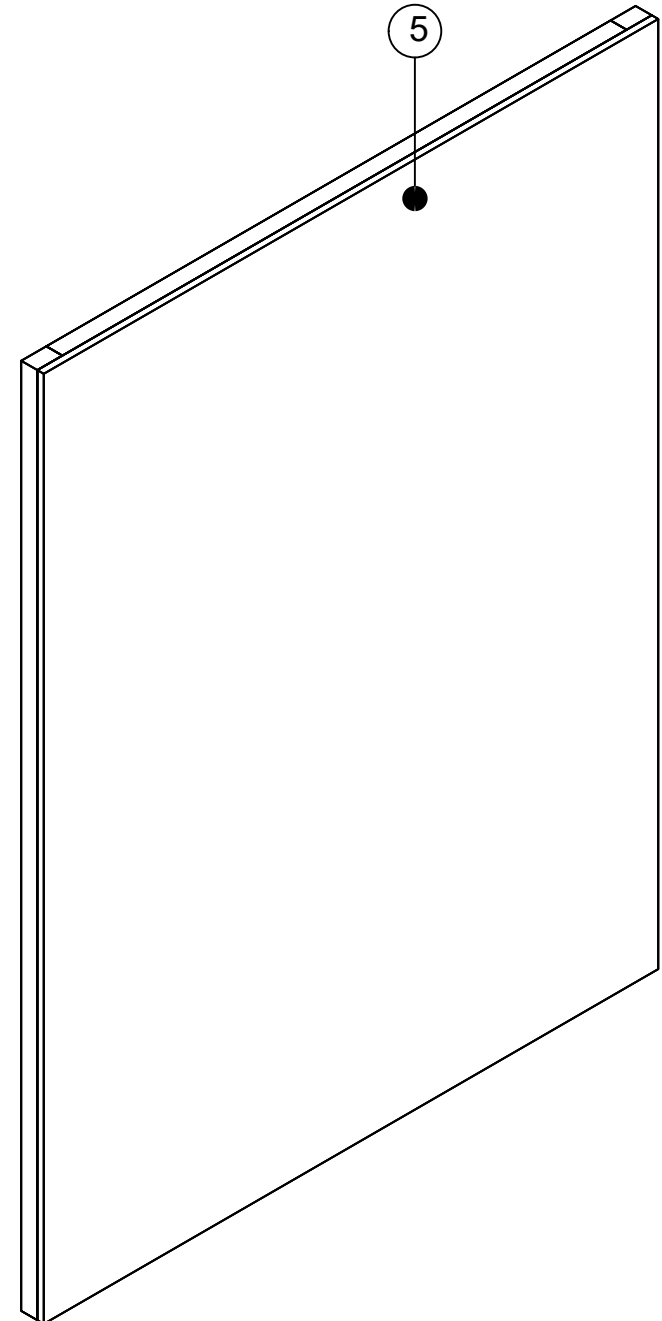

Tegen de muur vastzetten met slagpluggen

getekend	Fredsbouwtekeningen.nl	3 van 5
Tweepersoons opklapbed		A3

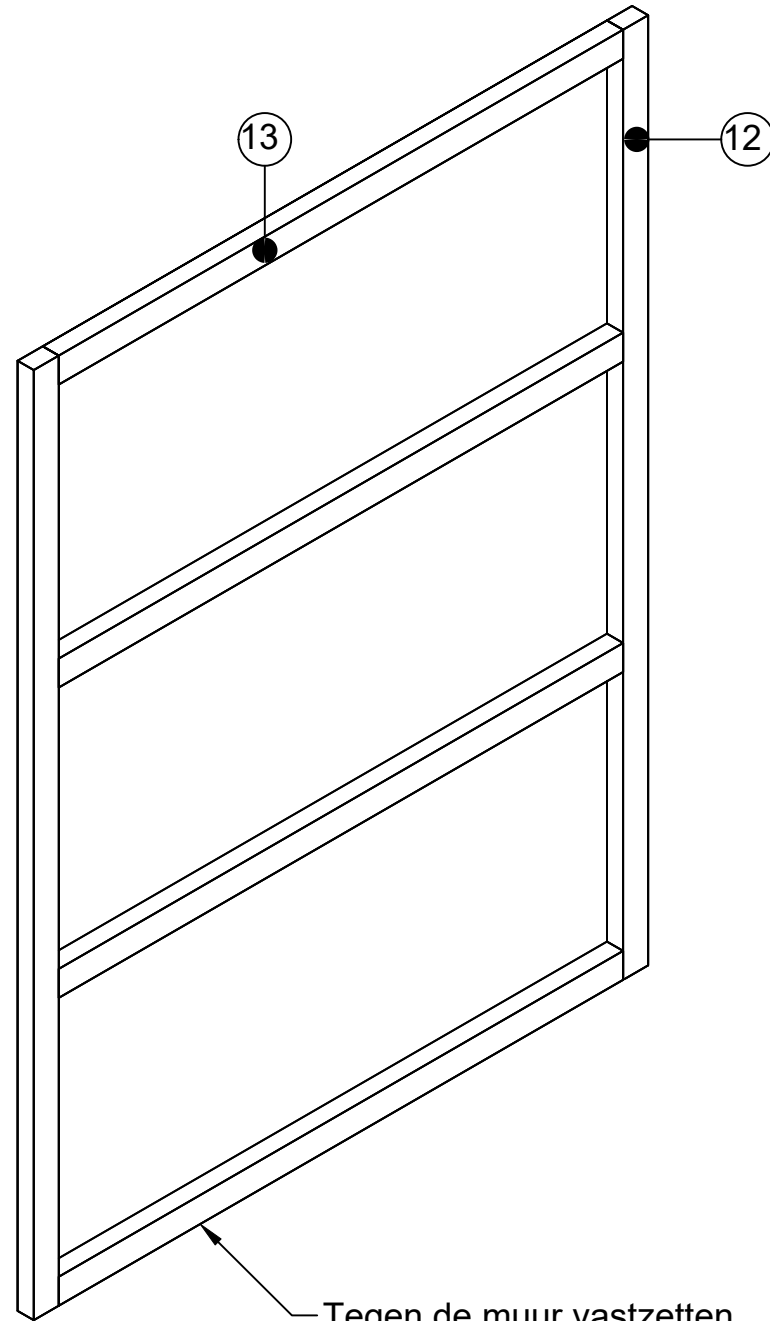
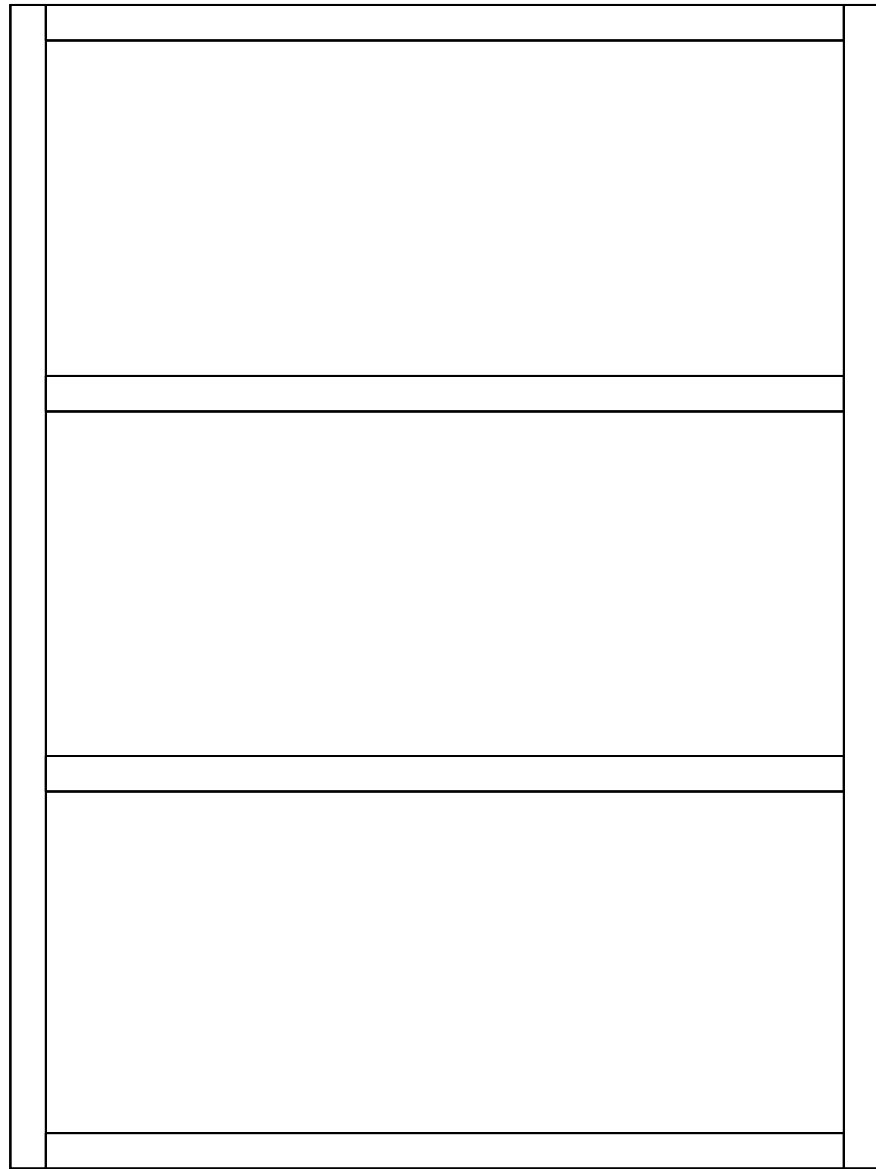
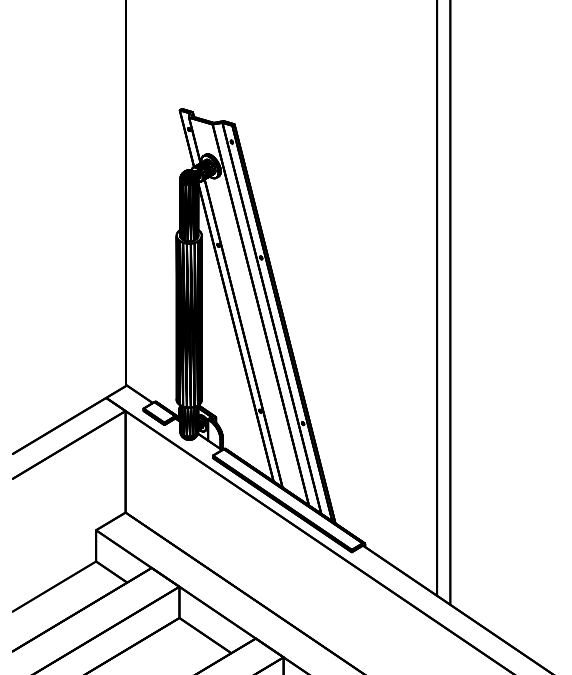
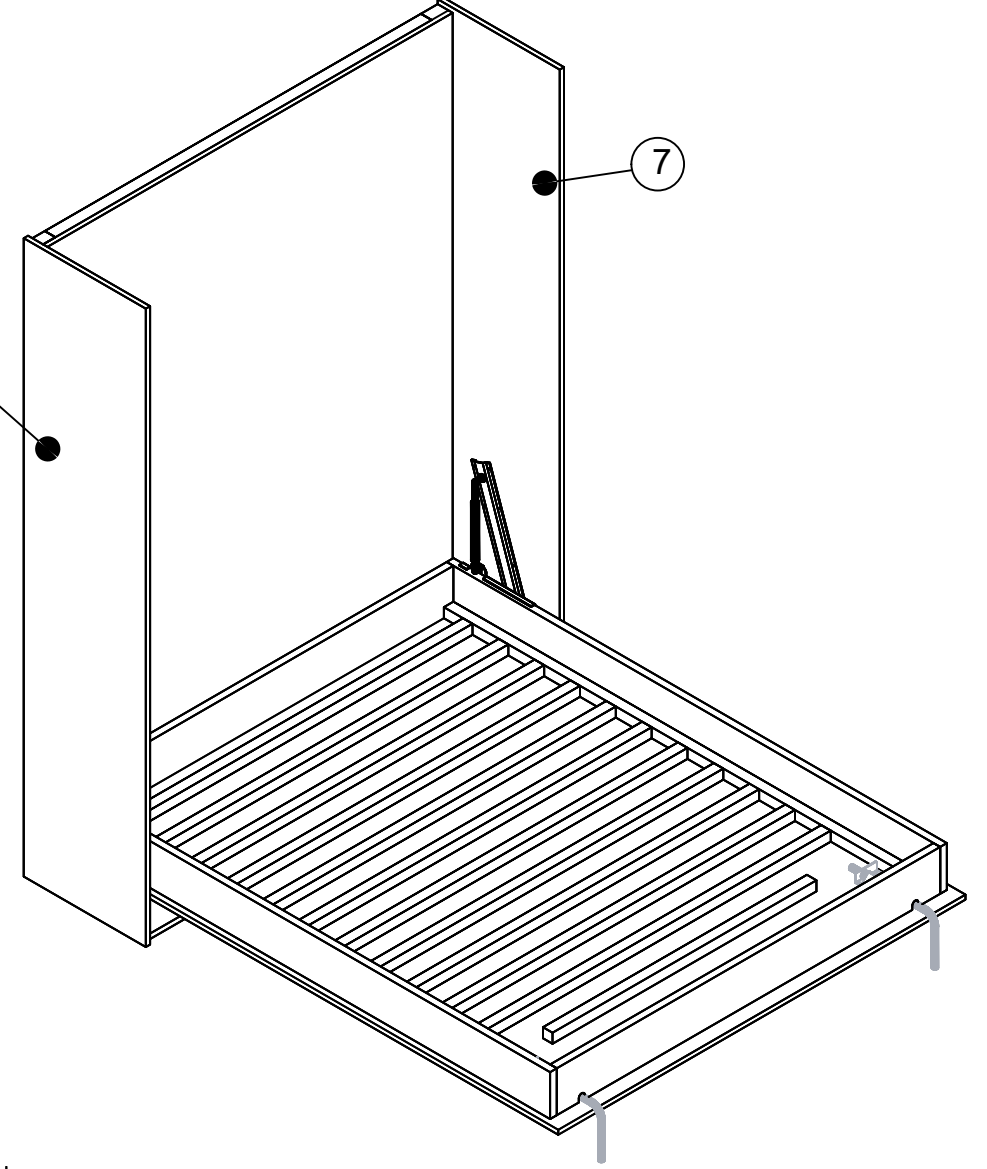
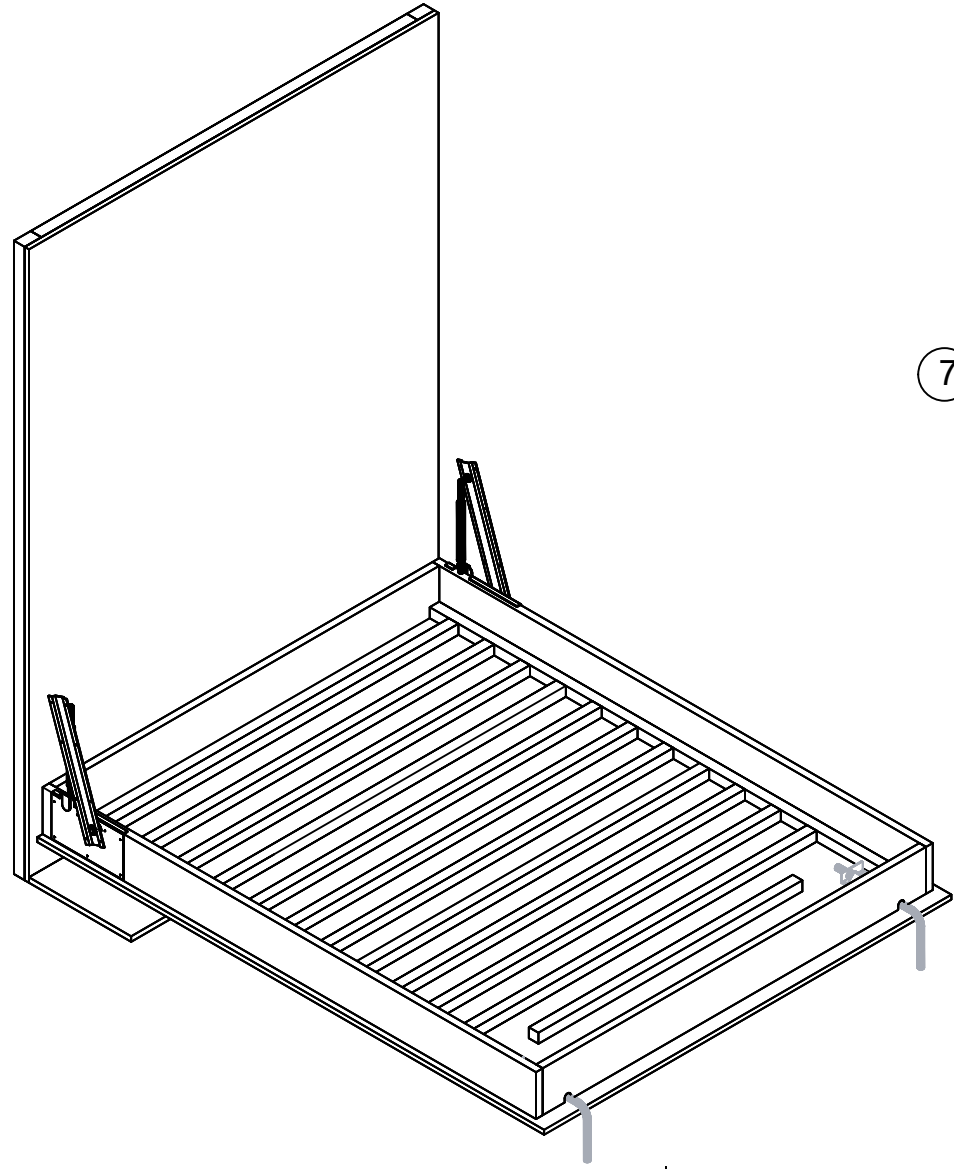
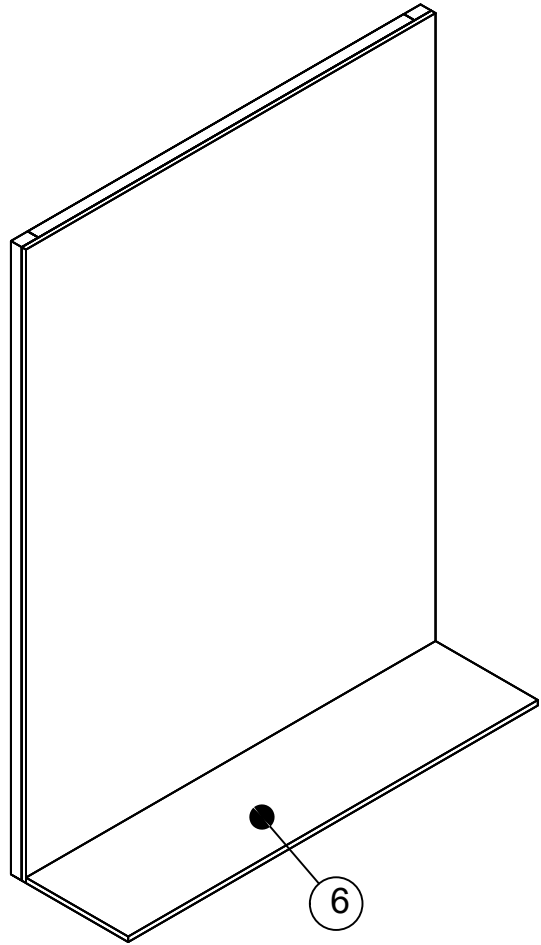

getekend	Fredsbouwtekeningen.nl	4 van 5
Tweepersoons opklapbed		A3

Klapbed					
Item	Aantal	Materiaal	Dikte	Breedte	Lengte
1	1	MDF	18	905	2122
2	2	MDF	18	170	2066
3	1	MDF	18	170	805
4	1	MDF	18	170	805
5	1	MDF	18	915	2296
6	1	MDF	18	428	915
7	2	MDF	18	511	2314
8	1	MDF	18	491	915
9	2	MDF	18	60	915
10	2	Vuren	40	40	2010
11	11	Vuren	40	40	925
12	2	Vuren	40	40	305
13	2	Vuren	45	70	2296
14	4	Vuren	45	70	765
15	2	Klapscharnier (rechts en links)			
16	2	Gasveer (tot 100kg)			
17	2	Bedlift klapvoet			
18	1	Handvat			
19	Slagpluggen 8x80mm				
20	RVS schroeven 4x40				
21	RVS schroeven 4x15 en 3x16				

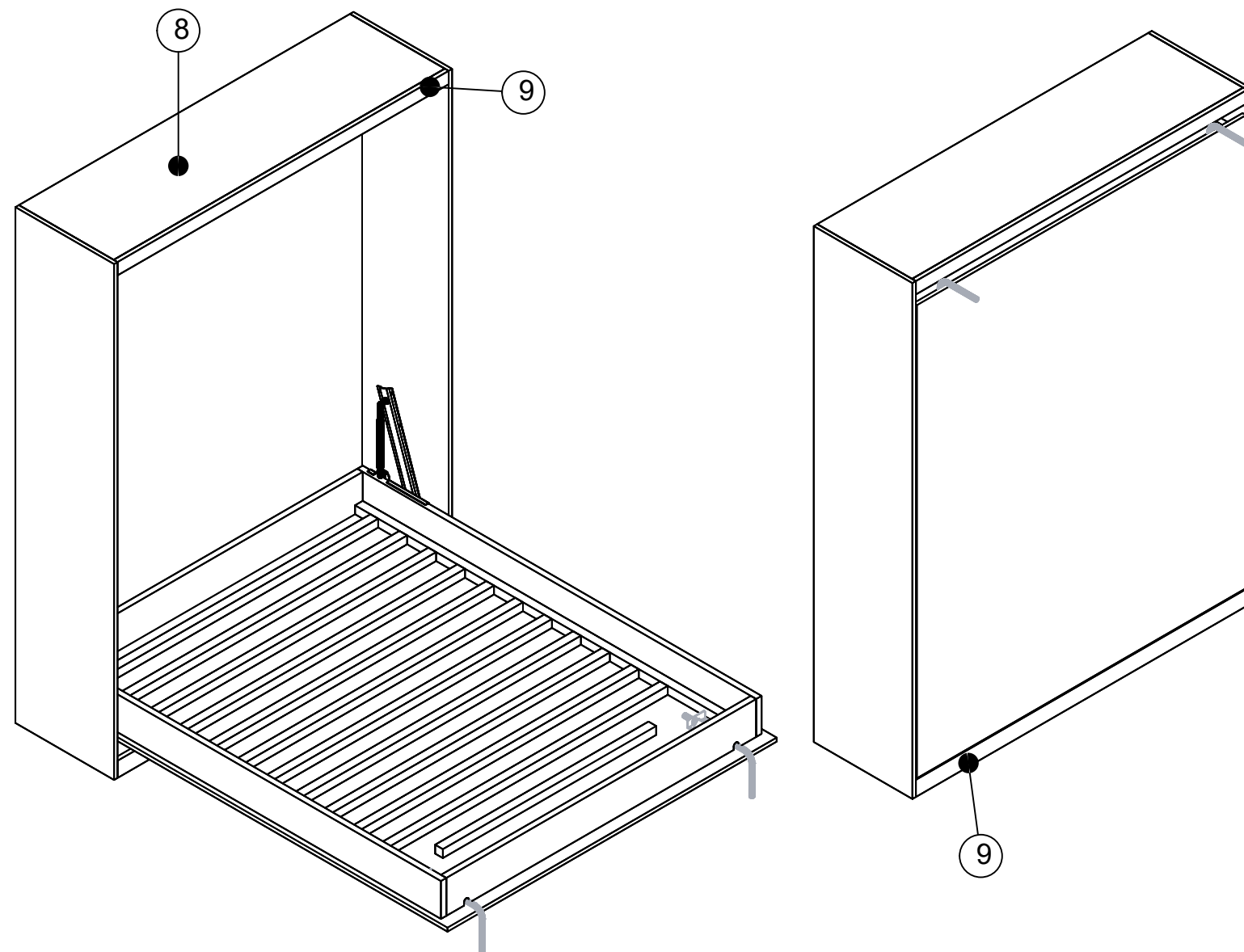

getekend	Fredsbouwtekeningen.nl	5 van 5
Tweepersoons opklapbed		A3