

getekend	Fredsbouwtekeningen.nl	1 van 4
Stalen werkbank		A3

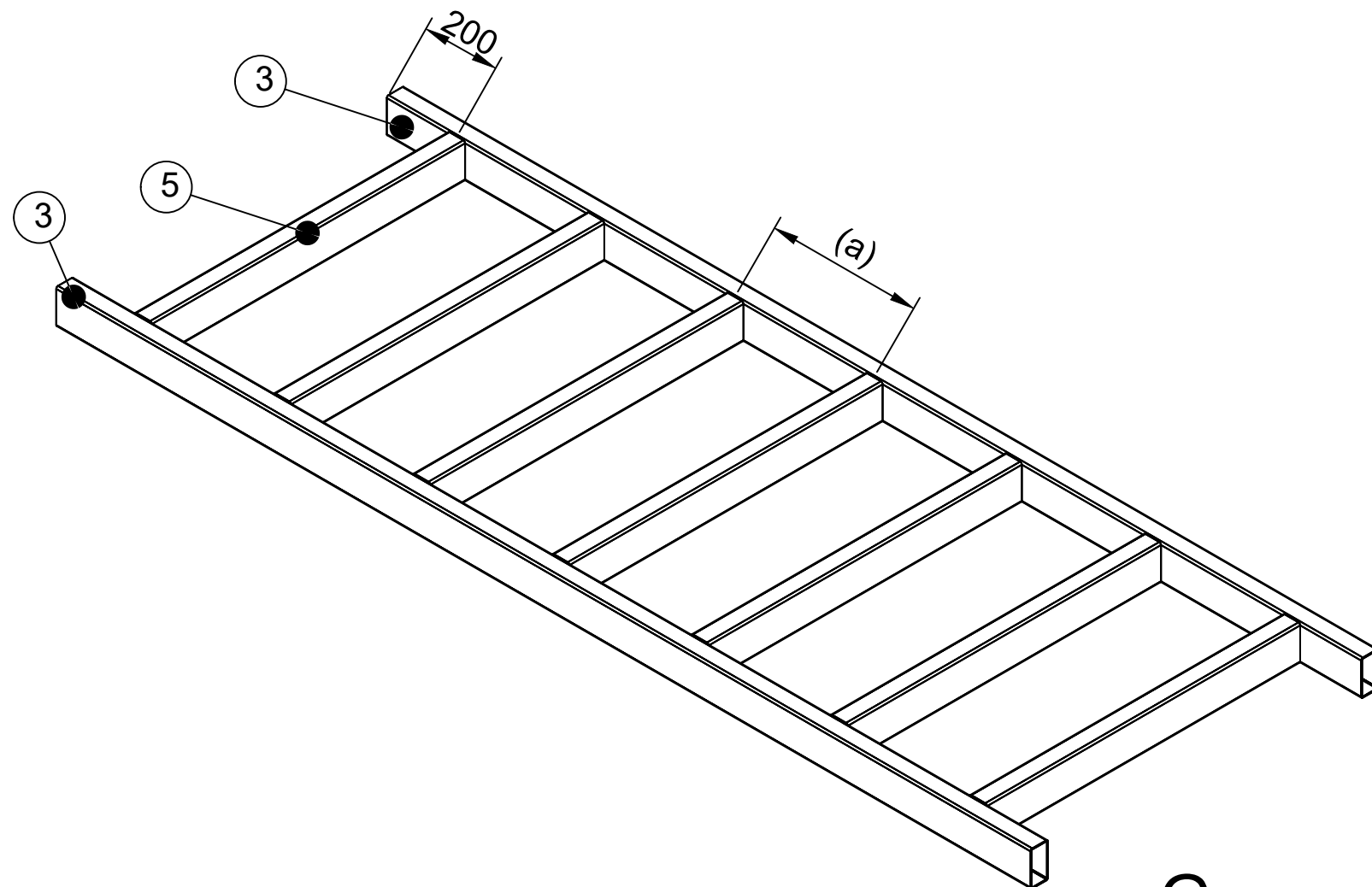

G

getekend	Fredsbouwtekeningen.nl	2 van 4
Stalen werkbank		A3

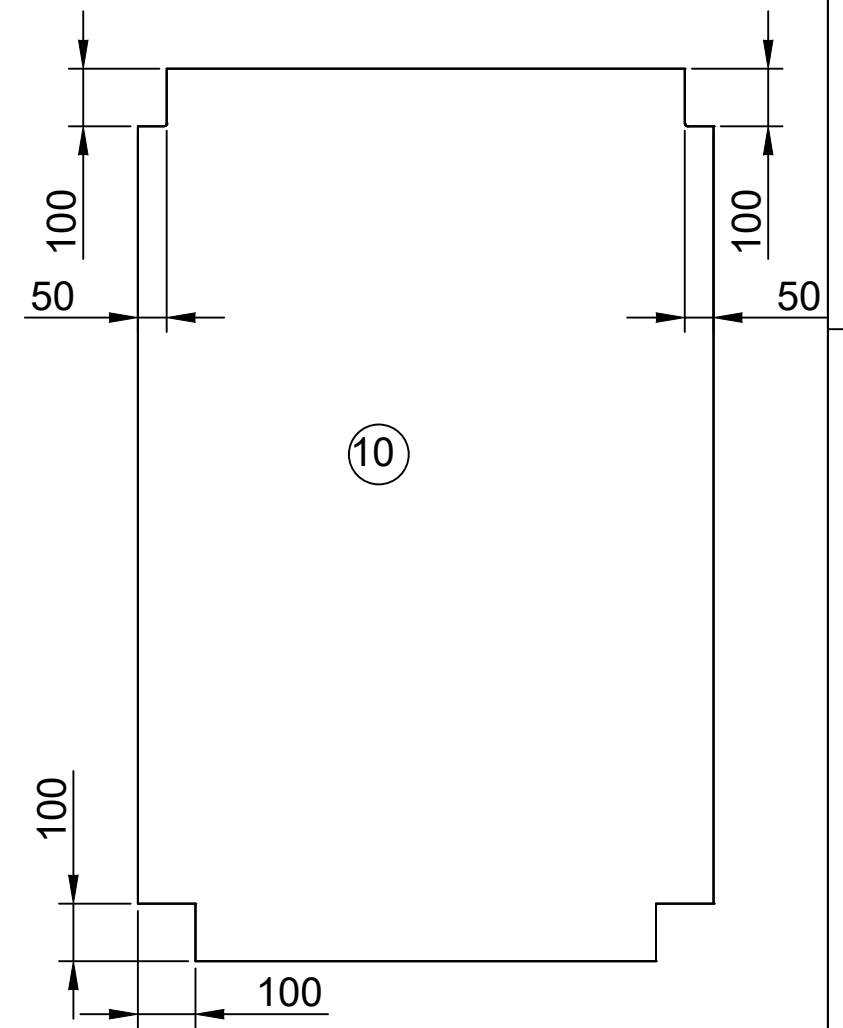
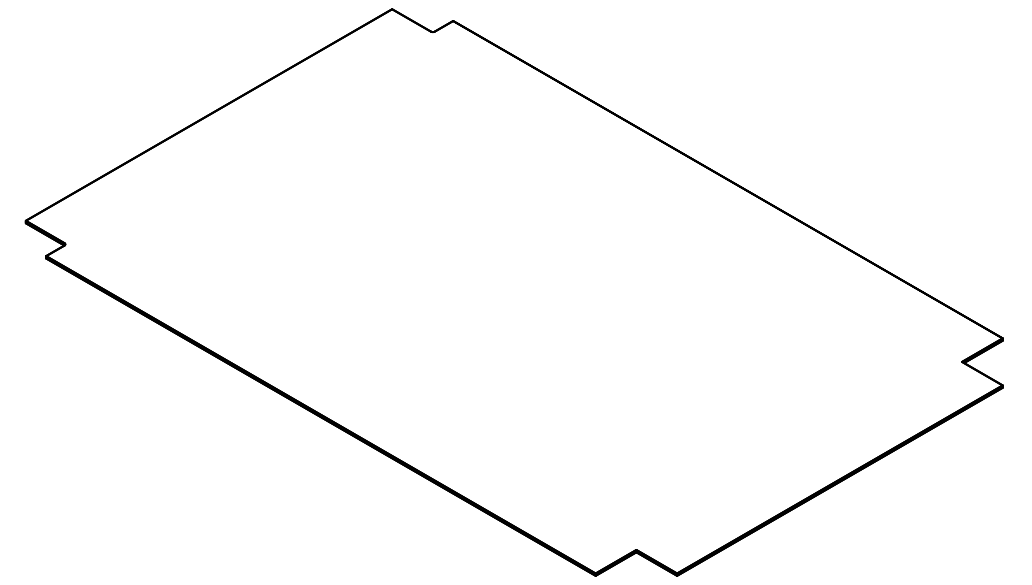
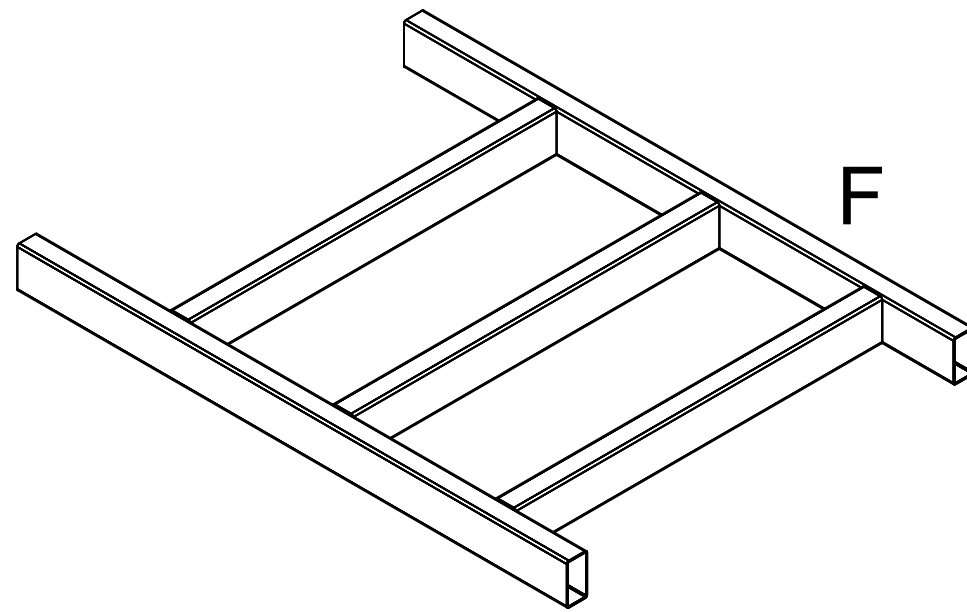
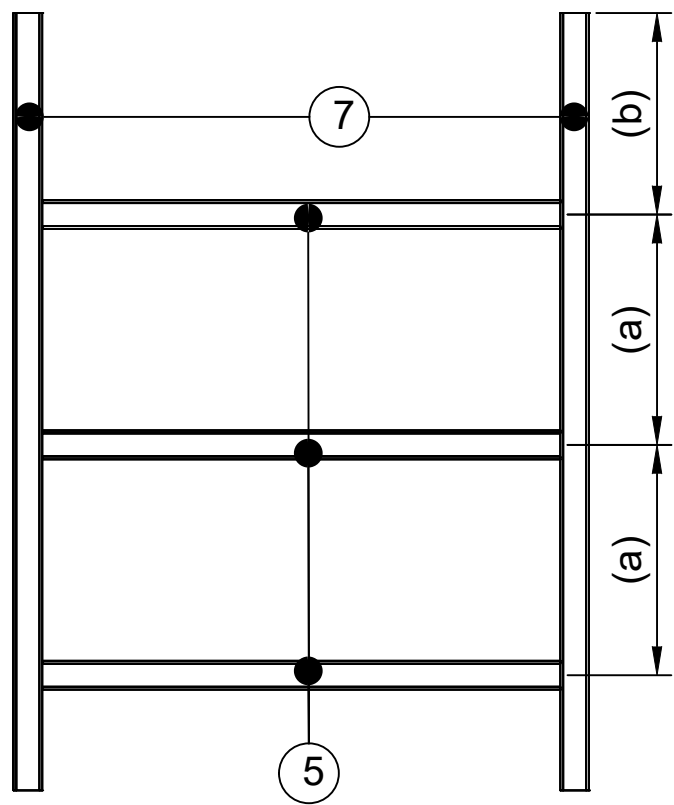
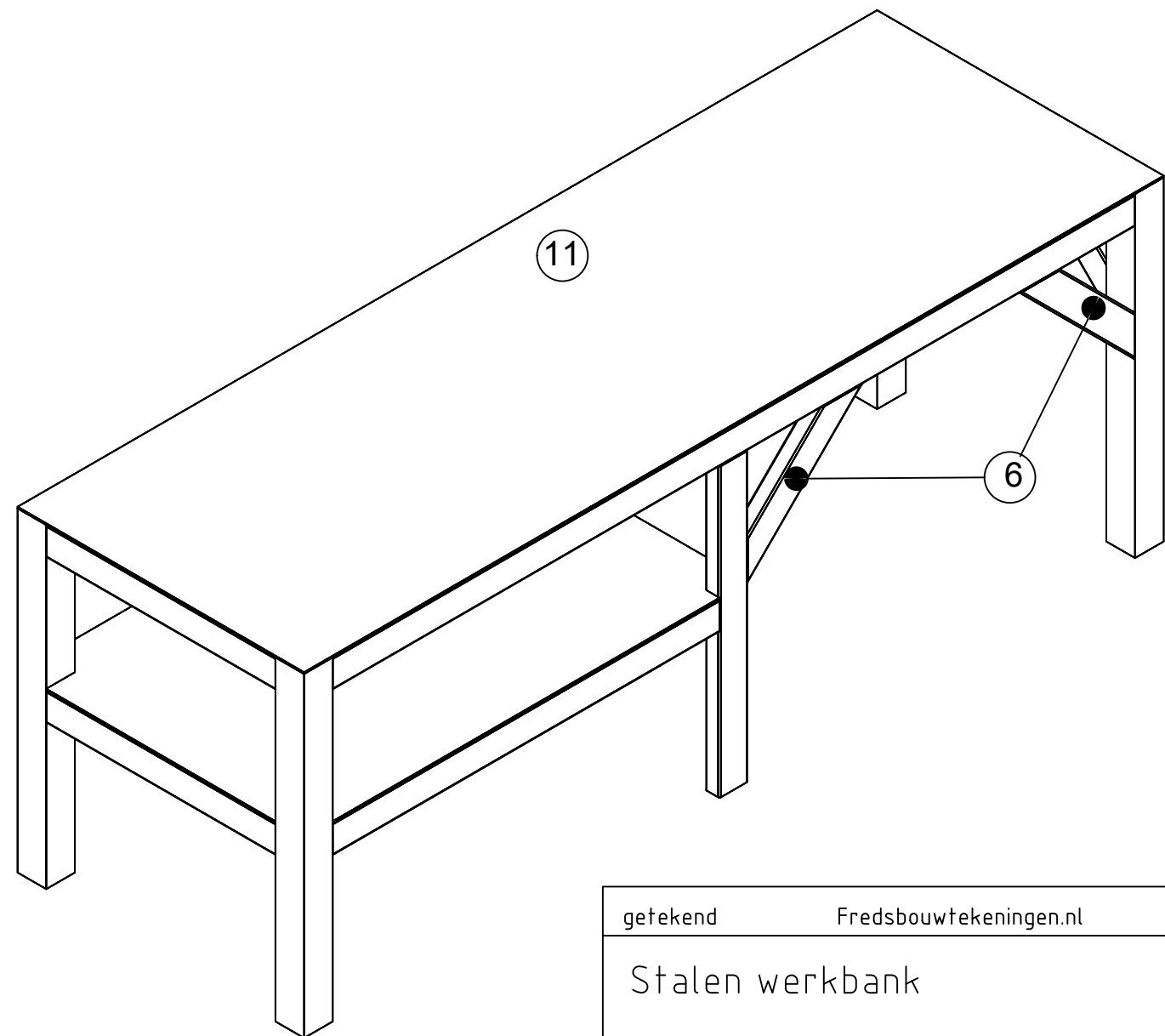
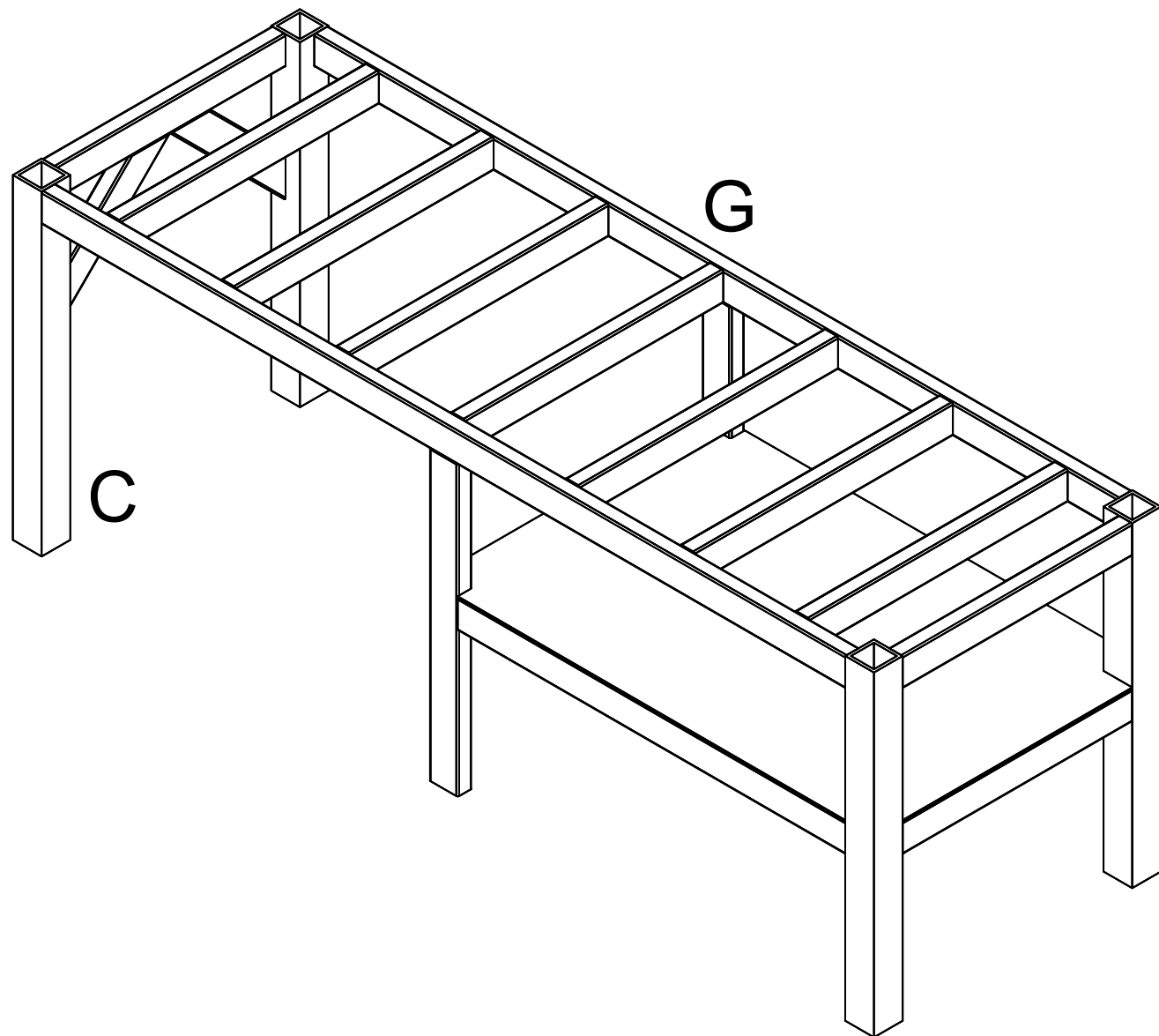
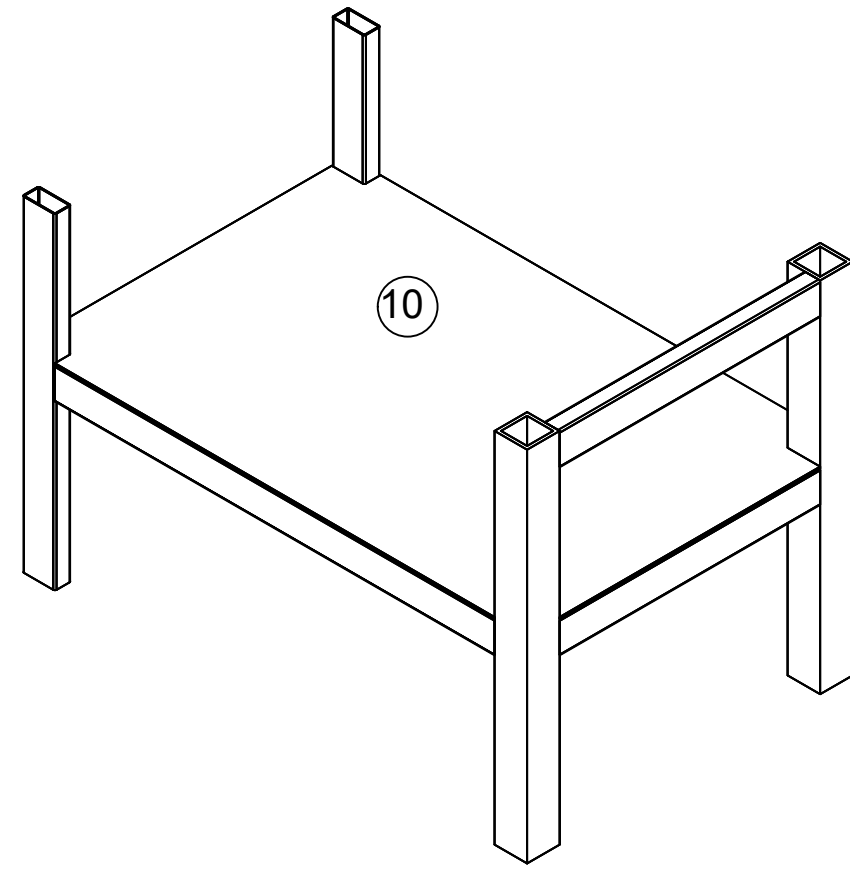
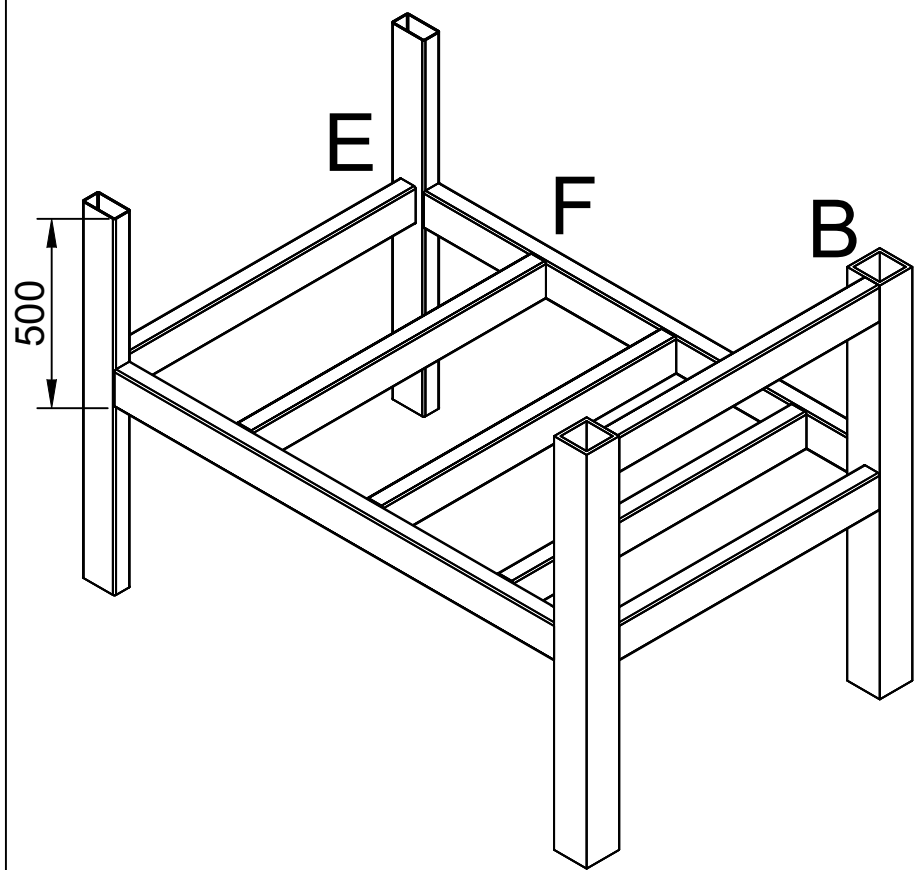

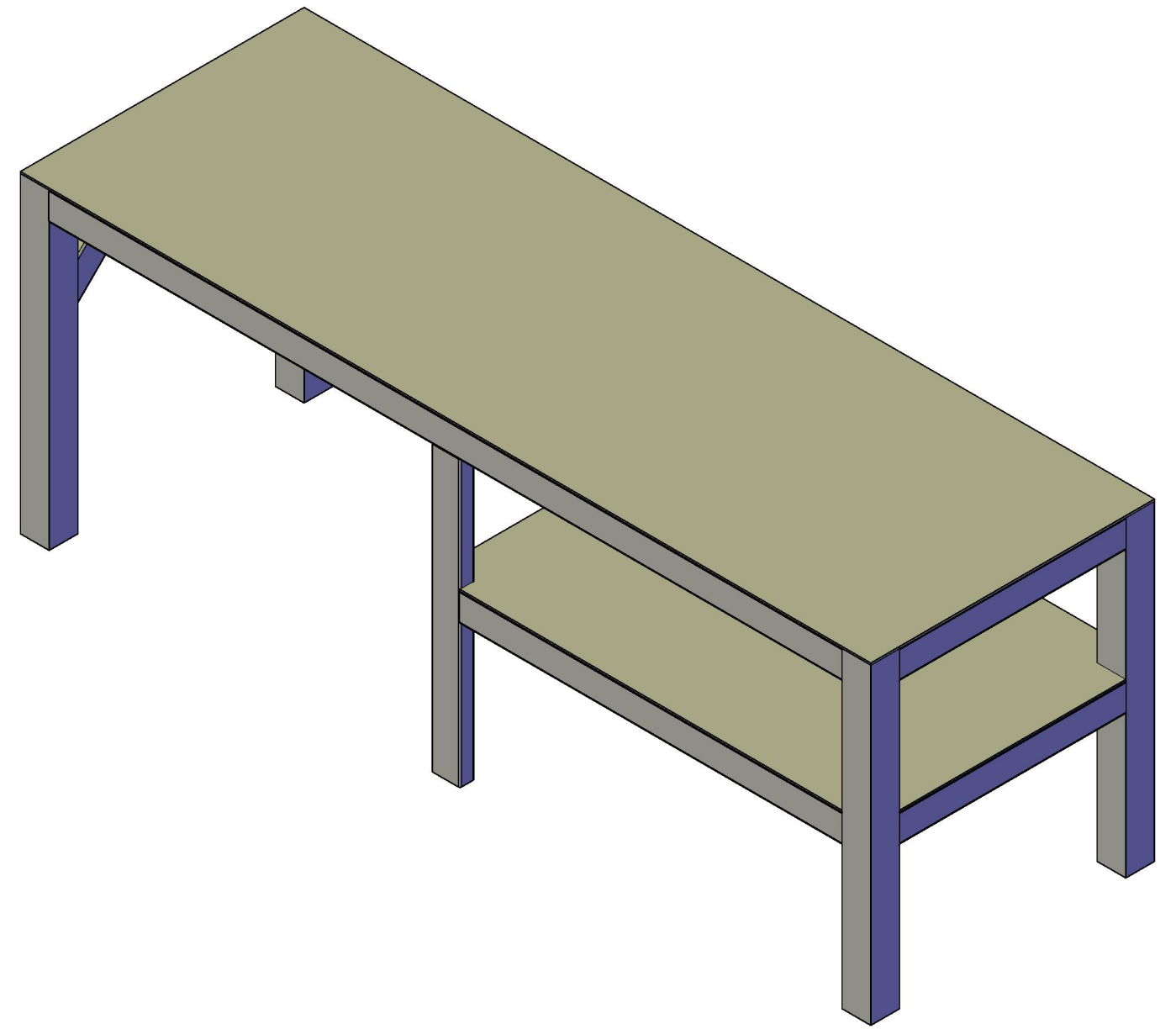

Maat	Lengte	Item	Aantal	Materiaal	Dikte	Breedte	Lengte
Hoogte	1100	1	4	Koker 100x100x10			1095
Breedte	1000	2	2	Koker 100x50x3			1095
Lengte	4000	3	2	Koker 100x50x3			3800
Plaatdikte	5	4	3	Koker 100x50x3			800
Maat	Lengte	5	11	Koker 100x50x3			900
(a)	567	6	4	Koker 100x50x3			565
(b)	517	7	2	Koker 100x50x3			1850
		8	4	Plaat	5	80	80
		9	2	Plaat	5	44	94
		10	1	Plaat	5	1000	2050
		11	1	Plaat	5	1000	4000

getekend	Fredsbouwtekeningen.nl	4 van
Stalen werkbank		A3